

ELECTRICAL & LIGHTING CATALOGUE



KHWAJA

ELECTRICAL DISTRIBUTORS

QUALITY
INOVATIVE
EXPERIENCED

WWW.KHWAJAELECTRICAL.CO.ZA

011 869 8885 | 011 869 8471

ISHRATH@KHWAJAELECTRICAL.CO.ZA | SALES@KHWAJAELECTRICAL.CO.ZA

Boards, Boxes & Kiosks

01

PVC Conduit

23

Plugs & Extensions

28

Streetlights & Post Tops

41

Channel Fittings

50

Surface Bodies

56

Recessed Bodies

58

Indoor Ceiling Fittings

64

CUSTOM MADE BOXES

Custom Made Distribution Boards manufactured as per your specifications. IP65 Outdoor or IP54 Indoor. Floor Standing DB's, Outdoor Kiosks, Enclosures, DOL's.

We can supply with copper Bussbars.

Materials Manufactured From: Mild Steel or Stainless Steel.

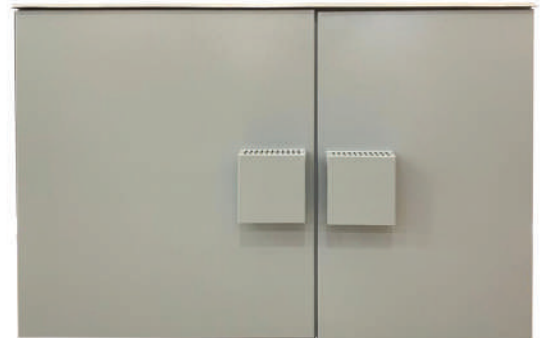

FREE STANDING METERING KIOSKS

Features

- Kiosk removable from base & frame
- Hot Dipped Galvanised or Stainless Steel Frame and Gland Plate
- Unistrut available in place of Gland Plate
- Stainless Steel Butt Hinges
- Lever Lock Handle or Stainless Steel Thru Lock
- Vents in Roof Overhang
- Busbar mounted on colour coded Insulators
- Nylon door restraints
- Can be supplied fully wired and fitted
- Phase, Neutral & Earth bars supplied as optional extras
- Available in Grey or Light Stone as Standard. Other Colours available on request



DESCRIPTION	WIDTH	HEIGHT	DEPTH	PLINTH(H)	BOARD	PLINTHSIZE
2 Way	360	680	430	405	470x290	510x460x405
4 Way	530	680	430	345	470x440	690x600x345
6 Way	530	900	430	345	650x440	690x600x345
9 Way	700	900	430	345	650x610	850x600x345
12 Way	700	1120	430	345	880x610	850x600x345
12 Way D	700	1280	430	410	1080x610	880x650x410
16 Way	800	1470	430	345	1220x740	990x660x345
24 Way	1120	1280	490	510	1080x980	1310x810x510
30 Way	1025	1580	580	490	1420x1000	1330x860x490

POLE MOUNTED KIOSKS

Features

- Hooks on back for strapping to pole
- Window-Polycarbonate
- Can be supplied fully wired and fitted
- Lift-Off front
- Available in Grey or Light Stone as Standard.



DESCRIPTION	WINDOW	WIDTH	HEIGHT	DEPTH
Mini	Nil	145	360	145
Distribution	Nil	320	640	270
2 Way Metering	One	320	640	270
3 Way Metering	Two	320	640	270

WALL MOUNT KIOSKS



Features

- Backing Board fitted
- Blank Gland Plate fitted
- Can be supplied fully wired and fitted
- Available in pole mounted version
- Available in Grey or Light Stone as Standard.

CODE	ITEM	SIZE
FWB115	Wall Mount Kiosk	695x360x245
FWB117	Wall Mount Kiosk	795x760x245
FWB9W	Wall Mount Kiosk (12 Way)	1310x1100x430
FWB16W	Wall Mount Kiosk (16 Way)	1310x1100x430
FWB6W2D	Wall Mount Kiosk 2 Door	980x1140x340

STUBBY KIOSKS

Features

- Lift-Off Top
- Frame, Unistrut & Locking Rod is Hot Dipped Galvanised
- Cable termination facility optional
- Can be supplied fully wired and fitted
- Window-Polycarbonate



DISTRIBUTION PILLARS



Features

- Lift-Off Top
- Frame, Unistrut & Locking Rod is Hot Dipped Galvanised
- Cable termination facility optional
- Can be supplied fully wired and fitted

SURFACE DIST. BOARDS 1 PHASE



CODE	SURFACE DIST. BOARDS 1 PHASE (SAMITE) – WHITE	OVERALL SIZE
DB04S	Surface Mount Dist. Board 04 Mod Samite	250 X 150 X 70
DB06S	Surface Mount Dist. Board 06 Mod Samite	250 X 175 X 70
DB08S	Surface Mount Dist. Board 08 Mod Samite	250 X 200 X 70
DB10S	Surface Mount Dist. Board 10 Mod Samite	250 X 250 X 70
DB12S	Surface Mount Dist. Board 12 Mod Samite	250 X 250 X 70
DB14S	Surface Mount Dist. Board 14 Mod Samite	250 X 275 X 70
DB16S	Surface Mount Dist. Board 16 Mod Samite	250 X 300 X 70
DB20S	Surface Mount Dist. Board 20 Mod Samite	250 X 350 X 70
DB24S	Surface Mount Dist. Board 24 Mod Samite	250 X 400 X 70

CODE	SURFACE DIST. BOARDS 1 PHASE (DIN) – WHITE	OVERALL SIZE
DB06D	Surface Mount Dist. Board 06 Mod DIN	250 X 200 X 70
DB09D	Surface Mount Dist. Board 09 Mod DIN	250 X 250 X 70
DB12D	Surface Mount Dist. Board 12 Mod DIN	250 X 250 X 70
DB15D	Surface Mount Dist. Board 15 Mod DIN	250 X 325 X 70
DB18D	Surface Mount Dist. Board 18 Mod DIN	250 X 350 X 70
DB21D	Surface Mount Dist. Board 21 Mod DIN	250 X 400 X 70
DB24D	Surface Mount Dist. Board 24 Mod DIN	250 X 450 X 70

FUSH ECONO BOARDS



CODE	FLUSH ECONO BOARDS + GALVANISED TRAY (SAMITE)	TRAY SIZE PER
EB06S	Flush Mount Dist. Boards 06Mod Samite	250 X 175 X 80
EB08S	Flush Mount Dist. Boards 08Mod Samite	250 X 200 X 80
EB12S	Flush Mount Dist. Boards 12Mod Samite	250 X 250 X 80
EB16S	Flush Mount Dist. Boards 16Mod Samite	250 X 300 X 80
EB20S	Flush Mount Dist. Boards 20Mod Samite	250 X 350 X 80
EB24S	Flush Mount Dist. Boards 24Mod Samite	250 X 400 X 80

CODE	FLUSH ECONO BOARDS + GALVANISED TRAY (DIN)	OVERALL SIZE
EB06D	Flush Mount Dist. Boards 06Mod DIN	250 X 200 X 80
EB09D	Flush Mount Dist. Boards 09Mod DIN	250 X 250 X 80
EB12D	Flush Mount Dist. Boards 12Mod DIN	250 X 300 X 80
EB15D	Flush Mount Dist. Boards 15Mod DIN	250 X 350 X 80
EB18D	Flush Mount Dist. Boards 18Mod DIN	250 X 400 X 80
EB21D	Flush Mount Dist. Boards 21Mod DIN	250 X 450 X 80
EB24D	Flush Mount Dist. Boards 24Mod DIN	250 X 500 X 80

SURFACE DIST. BOARDS 3 PHASE



CODE	SURFACE DIST. BOARDS 3 PHASE (SAMITE) - WHITE	OVERALL SIZE
DB3X08S	Surface Mount Dist. Board 3 X 08 Mod Samite	580 X 200 X 70
DB3X10S	Surface Mount Dist. Board 3 X 10 Mod Samite	580 X 225 X 70
DB3X12S	Surface Mount Dist. Board 3 X 12 Mod Samite	580 X 250 X 70
DB3X16S	Surface Mount Dist. Board 3 X 16 Mod Samite	580 X 300 X 70
DB3X20S	Surface Mount Dist. Board 3 X 20 Mod Samite	580 X 350 X 70
DB3X24S	Surface Mount Dist. Board 3 X 24 Mod Samite	580 X 400 X 70

CODE	SURFACE DIST. BOARDS 3 PHASE (DIN) - WHITE	OVERALL SIZE
DB3X06D	Surface Mount Dist. Board 3 X 06 Mod DIN	580 X 200 X 70
DB3X09D	Surface Mount Dist. Board 3 X 09 Mod DIN	580 X 250 X 70
DB3X12D	Surface Mount Dist. Board 3 X 12 Mod DIN	580 X 300 X 70
DB3X15D	Surface Mount Dist. Board 3 X 15 Mod DIN	580 X 350 X 70
DB3X18D	Surface Mount Dist. Board 3 X 18 Mod DIN	580 X 400 X 70

SURFACE DIST. BOARDS 2 PHASE



CODE	SURFACE DIST. BOARDS 2 PHASE (SAMITE) - WHITE	OVERALL SIZE
DB2X08S	Surface Mount Dist. Board 2 X 08 Mod Samite	410 X 200 X 70
DB2X10S	Surface Mount Dist. Board 2 X 10 Mod Samite	410 X 225 X 70
DB2X12S	Surface Mount Dist. Board 2 X 12 Mod Samite	410 X 250 X 70
DB2X16S	Surface Mount Dist. Board 2 X 16 Mod Samite	410 X 300 X 70
DB2X20S	Surface Mount Dist. Board 2 X 20 Mod Samite	410 X 350 X 70
DB2X24S	Surface Mount Dist. Board 2 X 24 Mod Samite	410 X 400 X 70

CODE	SURFACE DIST. BOARDS 2 PHASE (DIN) – WHITE	OVERALL SIZE
DB2X06D	Surface Mount Dist. Board 2 X 06 Mod DIN	410 X 200 X 70
DB2X09D	Surface Mount Dist. Board 2 X 09 Mod DIN	410 X 225 X 70
DB2X12D	Surface Mount Dist. Board 2 X 12 Mod DIN	410 X 250 X 70
DB2X15D	Surface Mount Dist. Board 2 X 15 Mod DIN	410 X 300 X 70
DB2X18D	Surface Mount Dist. Board 2 X 18 Mod DIN	410 X 350 X 70

SU FLUSH GALV TRAYS



CODE	SU FLUSH GALV TRAYS	OVERALL SIZE
SUF0T	SU Flush Tray 0	300 X 300 X 110
SUF1T	SU Flush Tray 1	300 X 455 X 110
SUF2T	SU Flush Tray 2	510 X 405 X 110
SUF3T	SU Flush Tray 3	715 X 405 X 110
SUF4T	SU Flush Tray 4	715 X 480 X 110
SUF5T	SU Flush Tray 5	715 X 570 X 110
SUF6T	SU Flush Tray 6	715 X 885 X 110
SUF7T	SU Flush Tray 7	715 X 990 X 110

SU FLUSH ARCHITRAVE BOARDS



CODE	SU FLUSH ARCHITRAVE BOARDS (SAMITE)	OVERALL SIZE
SUF0S	SU0 Flush Architrave Board, 1 x 12mod Samite	380 X 380
SUF1S	SU1 Flush Architrave Board, 1 x 24mod Samite	380 X 535
SUF2S	SU2 Flush Architrave Board, 2 x 20mod Samite	590 X 480
SUF3S	SU3 Flush Architrave Board, 3 x 20mod Samite	800 X 480
SUF4S	SU4 Flush Architrave Board, 3 x 28mod Samite	800 X 560
SUF5S	SU5 Flush Architrave Board, 3 x 32mod Samite	800 X 635
SUF6S	SU6 Flush Architrave Board, 3 x 32 + 3 x 12 Samite	800 X 950
SUF7S	SU7 Flush Architrave Board, 3 x 32 + 3 x 20 Samite	800 X 1055

CODE	SU FLUSH ARCHITRAVE BOARDS (DIN)	OVERALL SIZE
SUF0D	SU0 Flush Architrave Board, 1 x 09mod DIN	380 X 380
SUF1D	SU1 Flush Architrave Board, 1 x 18mod DIN	380 X 535
SUF2D	SU2 Flush Architrave Board, 2 x 15mod DIN	590 X 480
SUF3D	SU3 Flush Architrave Board, 3 x 15mod DIN	800 X 480
SUF4D	SU4 Flush Architrave Board, 3 x 21mod DIN	800 X 560
SUF5D	SU5 Flush Architrave Board, 3 x 24mod DIN	800 X 635
SUF6D	SU6 Flush Architrave Board, 3 x 24 + 3 x 09 DIN	800 X 950
SUF7D	SU7 Flush Architrave Board, 3 x 24 + 3 x 15 DIN	800 X 1055

SU FLUSH POST OFFICE TELE ARCHITRAVE BOARDS + MASONITE BOARD



CODE	SU FLUSH POST OFFICE TELE ARCHITRAVE BOARDS + MASONITE BOARD	OVERALL SIZE
SUPF0	SU0 Flush Post Office Telephone Board	380 X 380
SUPF1	SU1 Flush Post Office Telephone Board	380 X 535
SUPF2	SU2 Flush Post Office Telephone Board	590 X 480
SUPF3	SU3 Flush Post Office Telephone Board	800 X 480
SUPF4	SU4 Flush Post Office Telephone Board	800 X 560
SUPF5	SU5 Flush Post Office Telephone Board	800 X 635
SUPF6	SU6 Flush Post Office Telephone Board	800 X 950
SUPF7	SU7 Flush Post Office Telephone Board	800 X 1055

SU SURFACE CABINET BOARDS



CODE	SU SURFACE CABINET BOARDS (SAMITE)	OVERALL SIZE
SUS0S	SU0 Surface Cabinet Board, 1 x 12Mod Samite	325 X 325 X 150
SUS1S	SU1 Surface Cabinet Board, 1 x 24Mod Samite	480 X 325 X 150
SUS2S	SU2 Surface Cabinet Board, 2 x 20Mod Samite	535 X 430 X 150
SUS3S	SU3 Surface Cabinet Board, 3 x 20Mod Samite	775 X 430 X 150
SUS4S	SU4 Surface Cabinet Board, 3 x 28Mod Samite	775 X 510 X 150
SUS5S	SU5 Surface Cabinet Board, 3 x 32Mod Samite	775 X 585 X 150
SUS6S	SU6 Surface Cabinet Board, 3 x 32 + 3 x 12Mod Samite	775 X 930 X 150
SUS7S	SU7 Surface Cabinet Board, 3 x 32 + 3 x 20Mod Samite	775 X 1035 X 150

CODE	SU SURFACE CABINET BOARDS (DIN)	OVERALL SIZE
SUS0D	SU0 Surface Cabinet Board, 1 x 09Mod DIN	325 X 325 X 150
SUS1D	SU1 Surface Cabinet Board, 1 x 18Mod DIN	480 X 325 X 150
SUS2D	SU2 Surface Cabinet Board, 2 x 15Mod DIN	535 X 430 X 150
SUS3D	SU3 Surface Cabinet Board, 3 x 15Mod DIN	775 X 430 X 150
SUS4D	SU4 Surface Cabinet Board, 3 x 21Mod DIN	775 X 510 X 150
SUS5D	SU5 Surface Cabinet Board, 3 x 24Mod DIN	775 X 585 X 150
SUS6D	SU6 Surface Cabinet Board, 3 x 24 + 3 x 09Mod DIN	775 X 930 X 150
SUS7D	SU7 Surface Cabinet Board, 3 x 24 + 3 x 15Mod DIN	775 X 1035 X 150

FLUSH SIDE ISOLATOR BOARDS 3 PHASE



CODE	FLUSH SIDE ISOLATOR BOARDS 3PH – PROV FOR 100A ISOL +TRAY-WHITE	OVERALL SIZE
SIF3X12S	3 x 12 Mod Samite	800 X 560
SIF3X20S	3 x 20 Mod Samite	800 X 635
SIF3X32S	3 x 32 Mod Samite	800 X 1055

CODE	SURFACE SIDE ISOLATOR BOARDS 3PH – PROV FOR 100A ISOL -ORANGE	OVERALL SIZE
SIS3X12S	3X12 Mod Samite	775 X 510 X 150
SIS3X20S	3X20 Mod Samite	775 X 585 X 150
SIS3X32S	3X32 Mod Samite	775 X 1035 X 150

SU SURFACE WEATHERPROOF CABINET BOARDS



CODE	SU SURFACE WEATHERPROOF CABINET BOARDS (SAMITE)	OVERALL SIZE
SUSW0S	SU0 Surface Weatherproof Board, 1 x 12Mod Samite	325 X 325 X 150
SUSW1S	SU1 Surface Weatherproof Board, 1 x 24Mod Samite	480 X 325 X 150
SUSW2S	SU2 Surface Weatherproof Board, 2 x 20Mod Samite	535 X 430 X 150
SUSW3S	SU3 Surface Weatherproof Board, 3 x 20Mod Samite	775 X 430 X 150
SUSW4S	SU4 Surface Weatherproof Board, 3 x 28Mod Samite	775 X 510 X 150
SUSW5S	SU5 Surface Weatherproof Board, 3 x 32Mod Samite	775 X 585 X 150
SUSW6S	SU6 Surface Weatherproof Board, 3 x 32 + 3 x 12Mod Samite	775 X 930 X 150
SUSW7S	SU7 Surface Weatherproof Board, 3 x 32 + 3 x 20Mod Samite	775 X 1035 X 150

CODE	SU SURFACE WEATHERPROOF CABINET BOARDS (DIN)	OVERALL SIZE
SUSW0D	SU0 Surface Weatherproof Board, 1 x 09Mod DIN	325 X 325 X 150
SUSW1D	SU1 Surface Weatherproof Board, 1 x 18Mod DIN	480 X 325 X 150
SUSW2D	SU2 Surface Weatherproof Board, 2 x 15Mod DIN	535 X 430 X 150
SUSW3D	SU3 Surface Weatherproof Board, 3 x 15Mod DIN	775 X 430 X 150
SUSW4D	SU4 Surface Weatherproof Board, 3 x 21Mod DIN	775 X 510 X 150
SUSW5D	SU5 Surface Weatherproof Board, 3 x 24Mod DIN	775 X 585 X 150
SUSW6D	SU6 Surface Weatherproof Board, 3 x 24 + 3 x 09Mod DIN	775 X 930 X 150
SUSW7D	SU7 Surface Weatherproof Board, 3 x 24 + 3 x 15Mod DIN	775 X 1035 X 150

EAVES BOXES - PAINTED GREY



CODE	EAVES BOXES - PAINTED GREY	OVERALL SIZE
WD6S	Eave Boxes 06 Mod Samite	225 X 145 X 100
WD12S	Eave Boxes 12 Mod Samite	225 X 225 X 100
WD16S	Eave Boxes 16 Mod Samite	225 X 275 X 100
WD20S	Eave Boxes 20 Mod Samite	225 X 325 X 100
WD24S	Eave Boxes 24 Mod Samite	225 X 375 X 100
WD4D	Eave Boxes 04 Mod Din	225 X 145 X 100
WD9D	Eave Boxes 09 Mod Din	225 X 225 X 100
WD12D	Eave Boxes 12 Mod Din	225 X 275 X 100
WD15D	Eave Boxes 15 Mod Din	225 X 325 X 100
WD18D	Eave Boxes 18 Mod Din	225 X 375 X 100
CODE	23 - BUDGIE BOXES - GALVANISED - PAINTED GREY	OVERALL SIZE
BBP	Budgie Box Plain	230 X 150 X 200
BB06S	Budgie Box 6Mod Samite	231 X 150 X 200

ADJUSTABLE

CODE	ADJUSTABLE BOARDS	OVERALL SIZE
SAB20	Sml Adjust Board/Panel & Chassis 20Mod Samite	340 X 355
SAB15D	Sml Adjust Board/Panel & Chassis 15Mod DIN	340 X 355
MA1X28S	Medium Adjustable Board/Panel&Chassis 1x28Sam	565 X 340
MA2X20S	Medium Adjustable Board/Panel&Chassis 2x20Sam	565 X 340
MA2X15D	Medium Adjustable Board/Panel&Chassis 2x15Din	565 X 340
LAB2X28	Large Adjustable Board/Panel & Chassis 2 X 28 Sam	565 X 450
RR14D	Randfontein Ripple Relay 14 Mod Din	565 X 340
RR2X12S	Randfontein Ripple Relay 2 X 12 Samite	565 X 340

CODE	ADJUSTABLE TRAYS	OVERALL SIZE
SAT	Small Adjustable Tray Only	310 X 285 X 90
MAT	Medium Adjustable Tray	485 X 290 X 95
LAT	Large Adjustable Tray	555 X 290 X 95

NB.CUSTOM MADE DB BOARDS MANUFACTURED AS PER CLIENTS SPECIFICATIONS,MILD (EMPTY PANELS & COMPLETELY WIRED WITH EQUIPMENT + BUSSBARS)

CODE	CUSTOM MADE ENCLOSURES /DB BOARDS – (MILD STEEL-S.STEEL)	OVERALL SIZE
FD/JSO	JSO Enclosure - Surface Mount - Beige	555 X 180 X 105
3 X 12	Large Frame 3 x 12samite + Busbar, Double Door,Orange	
3 X 16	Large Frame 3 x 16samite + Busbar, Double Door,Orange	
3 X 20	Large Frame 3 x 20samite + Busbar, Double Door,Orange	
3 X 24	Large Frame 3 x 24samite + Busbar, Double Door,Orange	
3 X 32	Large Frame 3 x 32samite + Busbar, Double Door,Orange	
3 X 09DIN	Large Frame 3 x 09DIN + Busbar, Double Door,Orange	
3 X 12DIN	Large Frame 3 x 12DIN + Busbar, Double Door,Orange	
3 X 15DIN	Large Frame 3 x 15DIN + Busbar, Double Door,Orange	
3 X 18DIN	Large Frame 3 x 18DIN + Busbar, Double Door,Orange	
3 X 24DIN	Large Frame 3 x 24DIN + Busbar, Double Door,Orange	

METER BOXES



CODE	PRETORIA/BLOEMFONTEIN METER BOXES - PAINTED GREY	OVERALL SIZE
MBPT12X	Pretoria Meter Board, 300 x 300 x 225	300 X 300 X 225
MBPT12X	Pretoria Meter Board, 300 x 450 x 225	300 X 450 X 225
MBPT18X	Pretoria Meter Board, 450 x 450 x 225	450 X 450 X 225
MBPT18X	Pretoria Meter Board, 450 x 600 x 225	450 X 600 X 225
MBPT24X	Pretoria Meter Board, 600 x 600 x 225	600 X 600 X 225

CODE	ESKOM METER BOXES-MASONITE BACKING - PAINTED GREY	OVERALL SIZE
MBESP1	Eskom Meter Box Single Phase	760 X 320 X 220
MBESP3	Eskom Meter Box Three Phase	760 X 610 X 220

CODE	ESKOM METER BOXES-MASONITE BACKING - GALVANISED	OVERALL SIZE
MBESG1	Eskom Meter Box Single Phase	760 X 320 X 220
MBESG3	Eskom Meter Box Three Phase	760 X 610 X 220

CODE	JOHANNESBURG CITY COUNCIL METER BOXES- HOT DIPPED GALVANISED	OVERALL SIZE
ME1	JHB Metro Council ME 1 Box	510 X 350 X 205
ME3	JHB Metro Council ME 3 Box	690 X 580 X 230
BTB3	Back 2 Back Boundary 3 Phase Box, Hot Dip Galvanised	1000 X 660 X 350
JBP3NW	JHB Metro Council P3 Box, No Window Hot Dip Galv	870 X 460 X 180
JBP3	JHB Metro Council P3 Box, With Window Hot Dip Galv	871 X 460 X 180

GALVANISED DRAW BOXES + SCREW ON LID + KNOCKOUTS

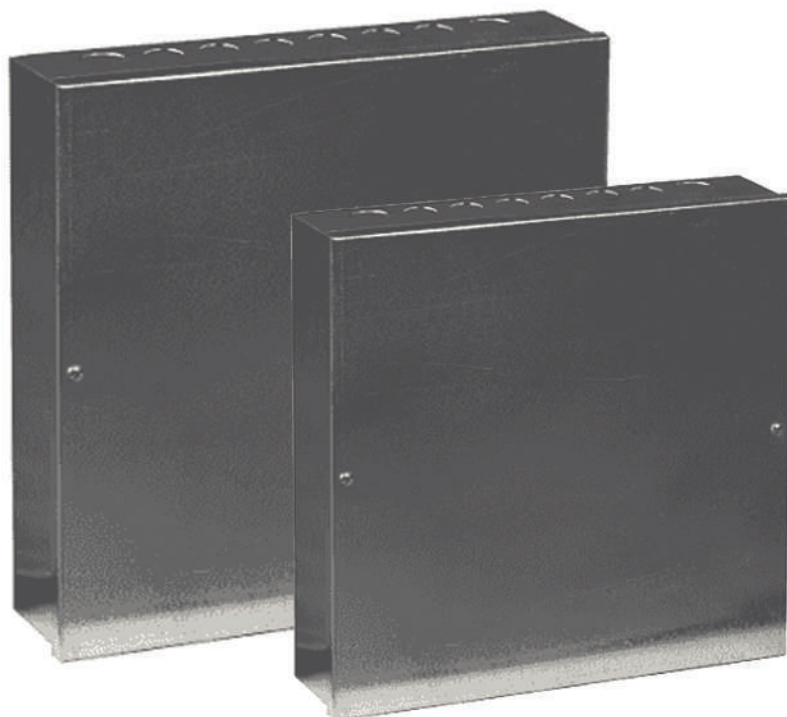

CODE	GALVANISED DRAW BOXES + SCREW ON LID + KNOCKOUTS	OVERALL SIZE
GDB04X04	Draw Boxes 100mm x 100mm x 50mm	100 X 100 X 50
GDB06X06	Draw Boxes 150mm x 150mm x 50mm	150 X 150 X 50
GDB06X06	Draw Boxes 150mm x 150mm x 75mm	150 X 150 X 75
GDB09X06	Draw Boxes 230mm x 150mm x 50mm	230 X 150 X 50
GDB09X06	Draw Boxes 230mm x 150mm x 75mm	230 X 150 X 75
GDB09X09	Draw Boxes 230mm x 230mm x 50mm	230 X 230 X 50
GDB09X09	Draw Boxes 230mm x 230mm x 75mm	230 X 230 X 75
GDB09X12	Draw Boxes 230mm x 305mm x 50mm	230 X 305 X 50
GDB09X12	Draw Boxes 230mm x 305mm x 75mm	230 X 305 X 75
GDB12X12	Draw Boxes 305mm x 305mm x 50mm	305 X 305 X 50
GDB12X12	Draw Boxes 305mm x 305mm x 75mm	305 X 305 X 75
GDB15X15	Draw Boxes 380mm x 380mm x 50mm	380 X 380 X 50
GDB15X15	Draw Boxes 380mm x 380mm x 75mm	380 X 380 X 75

GALVANISED SLAB BOXES

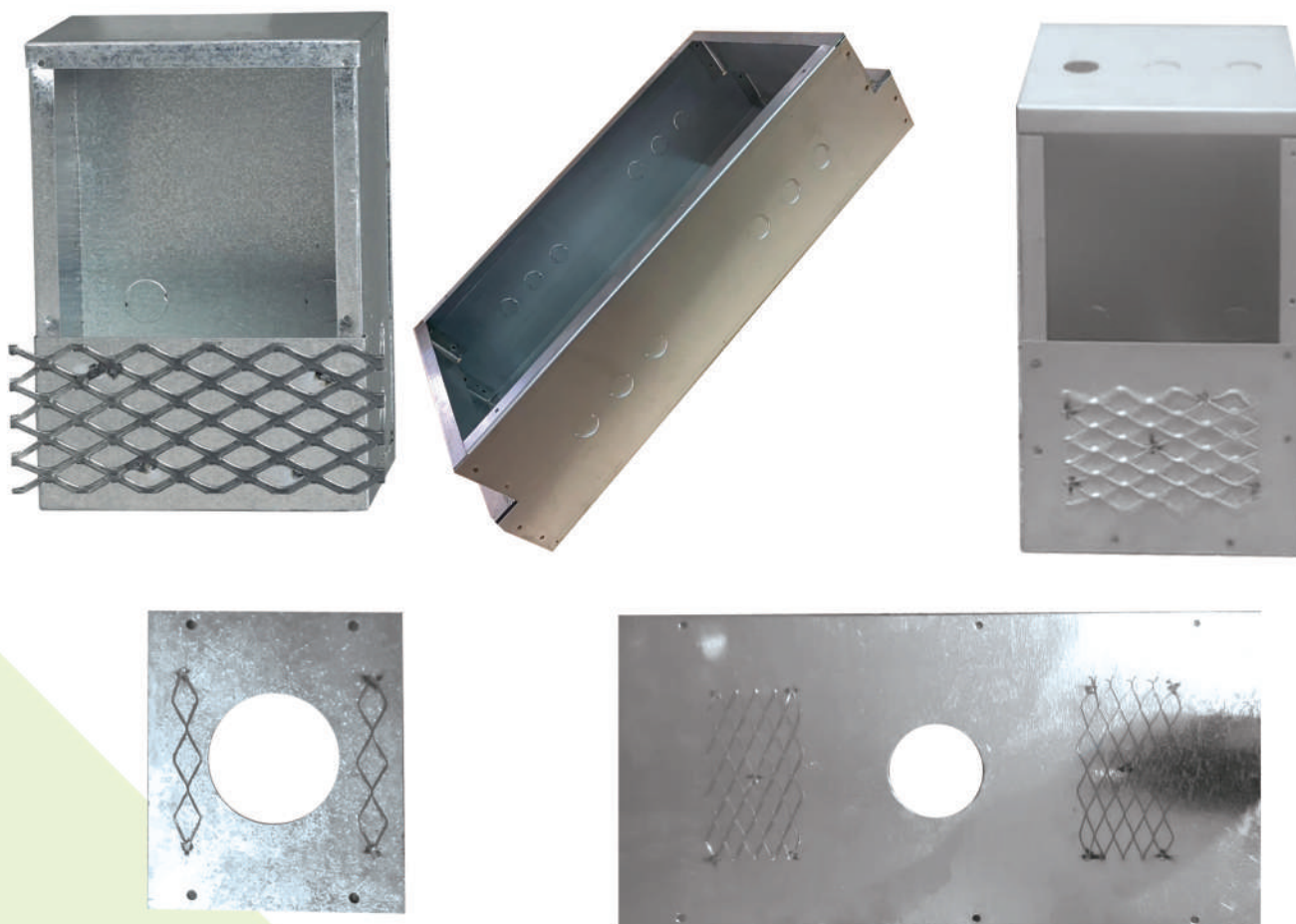

CODE	SLAB BOXES - GALVANISED	OVERALL SIZE
SB210	Light Fitting Slab Box 210mm	210 X 150 X 130
SB310	Light Fitting Slab Box 310mm	310 X 150 X 130
SB360	Light Fitting Slab Box 360mm	360 X 150 X 130
SB440	Light Fitting Slab Box 440mm	440/390 X 120 X 220
SB490	Light Fitting Slab Box 490mm	490/440 X 120 X 220
SB540	Light Fitting Slab Box 540mm	540/490 X 120 X 220
SB590	Light Fitting Slab Box 590mm	590/540 X 120 X 220
SB650	Light Fitting Slab Box 650mm	650/590 X 120 X 220
LFCL	Light Fitting Cover Plate 25mm - 115mm Lrg	150 X 130
LFCS	Light Fitting Cover Plate 25mm - 100mm Sml	290 X 220

IP55 ENCLOSURES

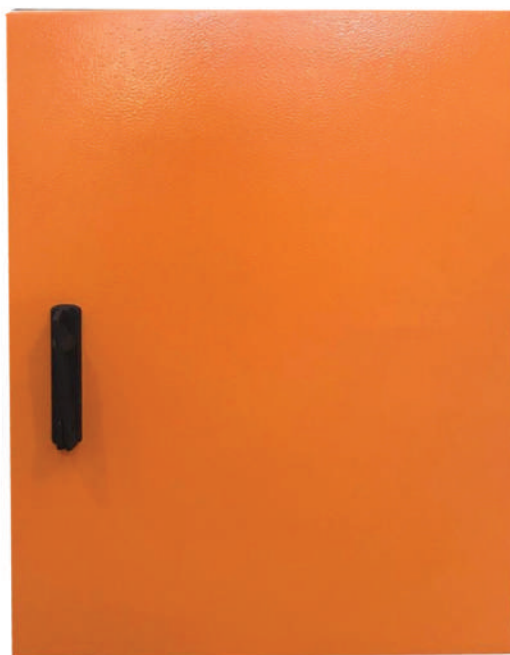

CODE	ENCLOSURES - IP55 - ORANGE	OVERALL SIZE
ENCL101	101, IP55 Enclosure, 175 x 250 x 170	175 X 250 X 170
ENCL102	102, IP55 Enclosure, 350 x 250 x 220	350 X 250 X 220
ENCL103	103, IP55 Enclosure, 450 x 300 x 220	450 X 300 X 220
ENCL 104	104, IP55 Enclosure, 550 x 400 x 220	550 X 400 X 220
ENCL 105	105, IP55 Enclosure, 650 x 450 x 270	650 X 450 X 270
ENCL106	106, IP55 Enclosure, 750 x 550 x 270	750 X 550 X 270
ENCL107	107, IP55 Enclosure, 950 x 700 x 270	950 X 700 X 270
WMB001	Wall Mounting Brackets per Set	

ACCESSORIES

CODE	ITEM	BOX QTY
PVC037	25MM SOLID BEND	150
PVC038	85MM OVERSIZE LIDS	500
PVC039	20MM FEMALE ADAPTOR	2000
PVC040	25MM MALE ADAPTOR	1000
PVC041	32MM MALE ADAPTOR	10
PVC042	50MM MALE ADAPTOR	10
PVC043	50MM COUPLING	10
PVC044	32MM FLEXABLE SADDLES	100
PVC045	32MM SOLID BEND	10
PVC046	50MM SOLID BEND	10
PVC047	25MM SPACER BAR SADDLES	100
PVC048	20MM INSPECTION ELBOW	100
PVC049	20MM PLAIN ELBOW	100
PVC050	20MM PLAIN TEE	100

CONDUIT

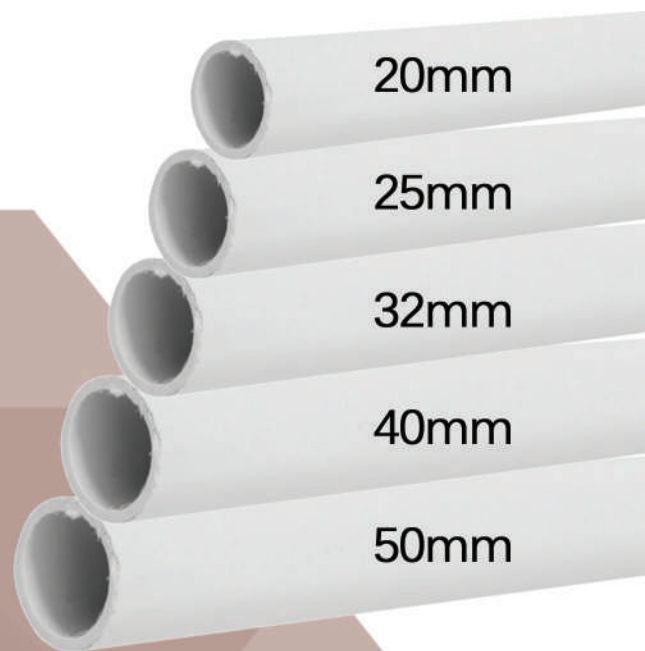

ACCESSORIES



U-Box



1 Way Side Entry Box



Inspection Elbow



2 Way Side Entry Box



Spacer Bar Saddle

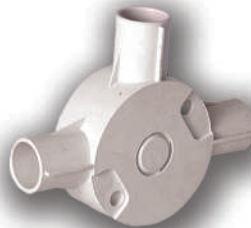

3 Way Side Entry Box



Strap Saddle



4 Way Side Entry Box



Solid Bend



Loop In Box



Sprague Tubing



Angle Box

ACCESSORIES



Coupling



Female Adaptor



Dome Lid



4X4 Extension Wall Box



Lid



4X2 Extension Wall Box



1 Way Back Entry Box



4X4 Flush Wall Box



2 Way Back Entry Box



4X2 Flush Wall Box



3 Way Back Entry Box



Inspection T



4 Way Back Entry Box



Y Box

TRUNKING



Sizes

CODE	SIZE	LENGTHS
YT-1	16X16	2m & 3m
YT-2	16X25	3m
YT-3	16X40	3m
YT-4	25X40	3m
YT-5	40X40	3m
NBT-4	40X100	3m

Industrial Trunking Also Available In Grey & White

CODE	SIZE	LENGTHS
CLT-1	50X50	3m
CLT-2	75X50	3m
CLT-3	75X75	3m
CLT-4	100X50	3m
CLT-5	100X75	3m
CLT-6	100X100	3m

ACCESSORIES

CODE	ITEM	BOX QTY
PVC001	1 WAY 20MM S/E	200
PVC002	1 WAY 25MM S/E	200
PVC003	2 WAY 20MM S/E	200
PVC004	2 WAY 25MM S/E	200
PVC005	3 WAY 20MM S/E	200
PVC006	3 WAY 25MM S/E	200
PVC007	4 WAY 20MM S/E	100
PVC008	4 WAY 25MM S/E	100
PVC009	20MM ANGLE WAY	200
PVC10	20MM U WAY	200
PVC011	20MM Y WAY	200
PVC012	29MM EXTENTION RING	200
PVC013	4 KNOCK OUT BOX 20MM	300
PVC014	8 KNOCK OUT BOX 20MM	300
PVC015	1 LOOP IN 20MM B/E	200
PVC016	2 LOOP IN 20MM B/E	200
PVC017	3 LOOP IN 20MM B/E	200
PVC018	4 LOOP IN 20MM B/E	200
PVC019	4X2 EXTENTION BOX	100
PVC020	4X2 EXTENTION BOX WITH KO	100
PVC021	4X4 EXTENTION BOX	70
PVC022	4X4 EXTENTION BOX WITH KO	70
PVC023	4X2 WALL BOX PLAIN	150
PVC024	4X2 WALL BOX WITH SPOUT	150
PVC025	4X4 WALL BOX PLAIN	100
PVC026	4X4 WALL BOX WITH SPOUT	100
PVC027	50MM BOX LIDS	1000
PVC028	20MM FLEXABLE SADDLES	3000
PVC029	25MM FLEXABLE SADDLES	2000
PVC030	20MM MALE ADAPTOR	2000
PVC031	20MM COUPLING	2000
PVC032	25MM COUPLING	1000
PVC033	32MM COUPLING	200
PVC034	20MM SPACER BAR SADDLES	1000
PVC035	20MM INSPECTION TEES	200
PVC036	20MM SOLID BEND	200

Multiplugs



KED-3+3+Switches MULTIPLUG

6 Way multiplug with 3 x 16A + 3 x 5A 2 pin sockets + 3 switches, complete with overload protection and moulded plug with cord.



KED-3 WAY MULTIPLUG

3 Way multiplug with 3 x 16A with overload protection and moulded plug + cord.



KED-5NS2+SURGE

10 Way multiplug with 5 x 16A + 4 x 5A 2 pin + 1 round socket, with overload & SURGE protection.



KED-6NS2 + SURGE

6 Way Multiplug with 3 x 16A + 3 x 5A 2 pin sockets complete with overload protection & SURGE protection.



KED-5 WAY MULTIPLUG

5 Way multiplug with 5 x 16A with overload protection and moulded plug with cord.

Multiplugs



KED-5NDED

Dedicated 5 Way multiplug with 5 x 16A with dedicated sockets with overload protection and moulded plug with cord.



KED-8NS2

8 Way multiplug with 4 x 16A + 3x 5A 2 pin + 1 round socket with overload protection and moulded plug with cord.



KED-8NS2 / 8WAY + USB MULTIPLUG

8 Way Multiplug with 4 X 16A + 3 X 5A 2 pin + 1 round socket with overload protection and moulded plug with cord ±



KED-8NS2SW

8 Way multiplug with 4 x 16A + 3x 5A 2 pin + 1 round socket with overload protection + control switch and moulded plug with cord.



KED-8NS2SW+SURGE

8 Way multiplug with 4 x 16A + 3x 5A 2 pin + 1 round socket with overload and Surge protection + control switch and moulded plug with cord.

Multiplugs



KED-3+3 MULTIPLUG

6 Way Multiplug with 3 x 16A + 3 x 5A 2 pin sockets

KED-3+3 MULTIPLUG +3M

KED-3+3 MULTIPLUG +5M



KED-6 MULTIPLUG

6 Way multiplug with 6 x 16A sockets complete with overload protection and moulded plug with cord.



KED-5+5 MULTIPLUG

10 Way multiplug with 5 x 16A + 4 x 5A 2 pin + 1 round socket, with overload protection.

KED-5+5 MULTIPLUG +3M CORD

KED-5+5 MULTIPLUG +5M CORD



KED-5+5+Switches MULTIPLUG

10 Way multiplug with 5 x 16A + 4 x 5A 2 pin + 1 round socket + 5 switches, complete with overload protection and moulded plug with cord.

Multiplugs

KED-Multi 8Way Multiplug + SWITCHES (PM166X)



KED-POWER CUBE - CUBE

KED-POWER CUBE - CUBE +USB



KED-1/2

1x 16A + 2x 5A Adaptor



KED-1/2+WITH LIGHT

1x 16A + 2x 5A Adaptor

KED-1/2+SURGE

1x 16A + 2x 5A Adaptor



KED-2

2x 16A Adaptor

Multiplugs



KED-2+ WITH LIGHT

2x 16A Adaptor

KED-2+SURGE

2x 16A Adaptor



KED-3

3x 16A Adaptor



KED-3 + WITH LIGHT

3x 16A Adaptor

KED-3 + SURGE

3x 16A Adaptor



KED-4

1x 16A + 2x 5A + 1x Round Adaptor



KED-4 WL

1x 16A + 2x 5A + 1x Round Adaptor
with light

Multiplugs



KED-SCHUKO: 1x 16A ROUND Adaptor



KED-1x5A: 1x 5A 2 pin / Euro Adaptor



KED-2x5A: 2x 5A 2 pin / Euro Adaptor



KED-3x5A: 3x 5A 2 pin / Euro Adaptor



KED-4x5A: 4x 5A 2 pin / Euro Adaptor

Multiplugs



KED-1+2x5A

1 Round 2 pin 16A + 2 flat 2 pin 5A
Adaptor



KED-2/2

2x 3Pin 16A + 2x flat 2 pin 5A
Horizontal Adaptor

KED-2/2+WITH LIGHT

2x 3Pin 16A + 2x flat 2 pin 5A
Horizontal Adaptor



KED-3/3

3x 3Pin 16A + 3x flat 2 pin 5A Horizontal Adaptor



KED-E3E

1x 3Pin 16A + 2x flat 2 pin 5A Adaptor



KED-1R+1x5A

1x Round 2pin 16A + 1x flat 2 pin
5A Adaptor

Multiplugs



KED-1x5A+1x5A
2x flat 2 pin 5A Adaptor



KED-2 Coupler
Double Janus Coupler
White



KED-2 Coupler
Double Janus Coupler
Black



KED-2 Rubber Coupler
Rubber Double Janus Coupler Black



KED-CL1331 PLUG
16A Plug Top
White



KED-CL1331 PLUG
16A Plug Top
BLACK
KED-A. Plug-DED:
16A Dedicated Plug Top Red

Multiplugs



KED-B. R-Plug Top:
16A Rubber Plug Top Black



KED-C. Funky Plug Top:
16A Plug Top White

KED- Funky Plug Top:
16A Plug Top Black



KED-Kettle Cord
Kettle cord with 16A



KED-24 Hour Timer
24 Hour Mechanical Timer.

Extension Cords



KED-SPEAKER WIRE – 0.5mm WHITE / AUDIO FLEX

100mm

5m

10m

20m



KED-10A Extension Cords

3m x 10A WITH DOUBLE COUPLER

5m x 10A WITH DOUBLE COUPLER

10m x 10A WITH DOUBLE COUPLER

15m x 10A WITH DOUBLE COUPLER

20m x 10A WITH DOUBLE COUPLER

25m x 10A WITH DOUBLE COUPLER



KED-16A Extension Cords

3m x 16A WITH DOUBLE COUPLER

5m x 16A WITH DOUBLE COUPLER

10m x 16A WITH DOUBLE COUPLER

15m x 16A WITH DOUBLE COUPLER

20m x 16A WITH DOUBLE COUPLER

Multiplugs & Adapters



KED-SA-UK Adaptor
SA to UK Adaptor 16A



KED-UNIV Adaptor – Universal
Adaptor 16A



KED-USB2 Adaptor – 2X USB
Adaptor 5V 1A



KED-5USB 2.1A Adaptor
1X Flat + 1x Schuko 16A + **2X USB 2.1A** + 1x 3pin 16A Adaptor



KED-5USBS (Surge) Adaptor
1X Flat + 1x Schuko 16A + **2X USB 2.1A** +
+ 1X 3pin 16A + Surge Adaptor

Extension Cords



KED-10m Closed Extension Reel

With 1.0mm Cable

– Polybagged and 10 per carton.



KED-20m Open Extension Reel

With 1.0mm Cable

– Each polybagged and 1 per carton.

KED-20m Open Extension Reel

With 1.5mm Cable

– Each polybagged and 1 per carton.



KED-30m Open Extension Reel

With 1.5mm Cable

– Each polybagged and 1 per carton.



KED-Empty Metal Reel

KED-20m Open Extension Metal Reel

With 1.0mm Cable

– Each polybagged and 1 per carton.

With 1.5mm Cable

– Each polybagged and 1 per carton.

Multiplugs



KED-Multi 5Way Multiplug(PM163X)

5 Way multiplug with 3 x 16A + 1x 5A
2 pin + 1 round socket with overload

KED-Multi 5Way Multiplug+3M Cord(PM167X)

KED-Multi 5Way Multiplug+5M Cord(PM168X)



KED-Multi 8Way Multiplug(PM164X)

8 Way multiplug with 4 x 16A + 2x 5A
2 pin + 2 round socket with overload

KED-Multi 8Way Multiplug+3M Cord(PM169X)

KED-Multi 8Way Multiplug+5M Cord(PM170X)



KED-Multi 5Way Multiplug + SWITCHES (PM165X)

FIBREGLASS STREETLIGHT POLES

PRODUCT CODE	POLE LENGHT	MOUNTING HEIGHT	WEIGHT	TOP DIAMETER	BOTTOM DIAMETER
3F/LPS/2.0/76/D/G	2.5MTR	2MTR	8KG	85MM	125MM
3F/LPS/2.5/76/D/G	3.1MTR	2.5MTR	9KG	85MM	130MM
3F/LPS/3.0/76/D/G	3.6MTR	3MTR	9.8KG	85MM	135MM
3F/LPS/3.5/76/D/G	4.1MTR	3.5MTR	10.9KG	85MM	145MM
3F/LPS/4.0/76/D/G	4.6MTR	4MTR	11.5KG	85MM	155MM
3F/LPS/4.6/76/D/G	5.2MTR	4.6MTR	13KG	85MM	165MM
3F/LPS/5/76/D/G	5.7MTR	5MTR	14.5KG	85MM	165MM
3F/LPS/5.0/76/D/G	6MTR	5MTR	15KG	85MM	175MM
3F/LPS/5.5/76/D/G	6.3MTR	5.5MTR	17KG	85MM	185MM
3F/LPS/6/76/D/G	6.9MTR	6MTR	20KG	85MM	195MM
3F/LPS/6.5/76/D/G	7.4MTR	6.5MTR	25KG	95MM	205MM
3F/LPS/7/76/D/G	8MTR	7MTR	30KG	95MM	220MM
3F/LPS/7.5/76/D/G	8.6MTR	7.5MTR	33KG	95MM	230MM
3F/LPS/8/76/D/G	9.2MTR	8MTR	38KG	95MM	245MM
3F/LPS/8.5/76/D/G	9.8MTR	8.5MTR	42KG	95MM	250MM
3F/LPS/9/76/D/G	10.4MTR	9MTR	46.5KG	95MM	265MM
3F/LPS/9.5/76/D/G	11MTR	9.5MTR	50KG	95MM	270MM
3F/LPS/10/76/D/G	11.6MTR	10MTR	55KG	95MM	275MM
3F/LPS/10.5/76/D/G	12.2MTR	10.5MTR	65KG	100MM	285MM

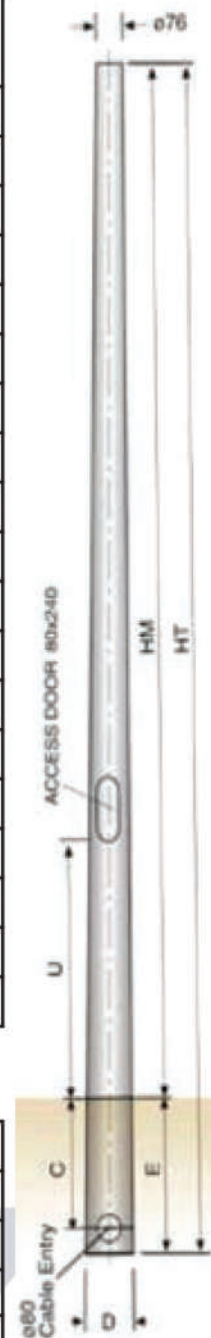

GLAND PLATES

3F 300 SQ	300 X 300 SQ	LAMINATED ON BASE PLATE
3F 300 SQ	400 X 400 SQ	LAMINATED ON BASE PLATE
3F 250 SQ	250 X 250 SQ	LAMINATED ON BASE PLATE
3F/LPS/4/63/D/G	4M	5M SLIM LINE
3F/LPS/7/42/D/G	7M	8M SAPREF

STEP POLES

HT	MH	D1	D2	D3
3M	2,5M	1M X 114 OD X 3MM	2M X 76 OD X 3MM	500MM
3,6M	3M	1,5M X 114 OD X 3MM	2M X 76 OD X 3MM	600MM
4,1M	3,5M	1,5M X 114 OD X 3MM	2,6M X 76 OD X 3MM	600MM
4,6M	4M	2M X 114 OD X 3MM	2,6M X 76 OD X 3MM	600MM
5,2M	4,5M	2,2M X 114 O/D X 3MM	3M X 76 OD X 3MM	700MM
6M	5M	3M X 114 OD X 3MM	3M X 76 OD X 3MM	1000MM
6,5M	5,5M	3M X 114 OD X 3MM	3,5M X 76 OD X 3MM	1000MM
7M	6M	3M X 114 OD X 3MM	4M X 76 OD X 3MM	1000MM
8M	7M	3M X 127 OD X 3MM	5M X 76 OD X 3MM	1000MM
9M	8M	3M X 127 OD X 3MM	6M X 76 OD X 3MM	1000MM

Typical Single Step Pole

Mounting Methods

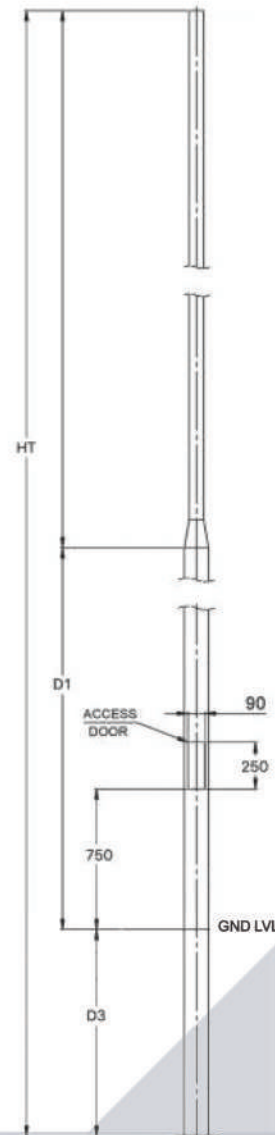
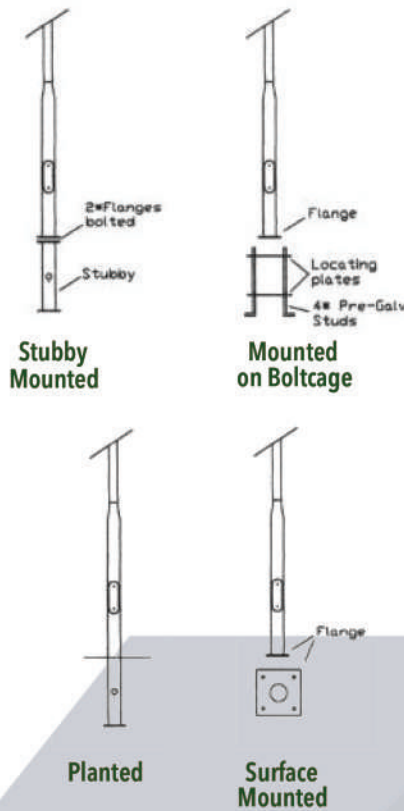
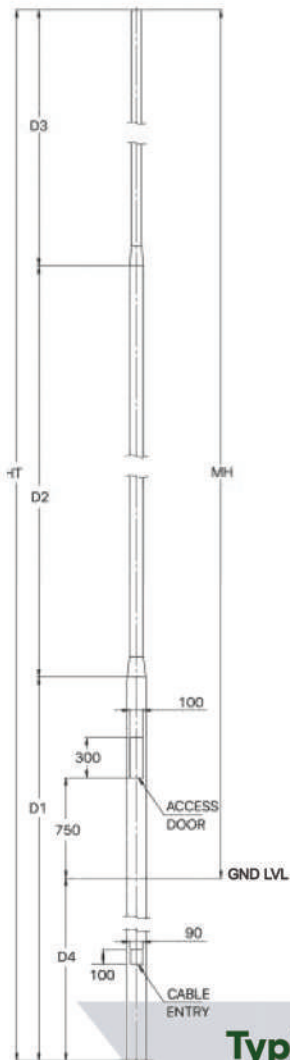

Typical Two Step Pole

HT.	MH.	D1.	D2.	D3.	D4.
9M	8M	3M X 127OD X 3MM	3M X 89OD X 3MM	3M X 76OD X 3MM	1000MM
10,5M	9M	3M X 127OD X 3MM.	3M X 89OD X 3MM	4,5M X 76OD X 3MM	1500MM
11M	9,5M	3M X 139OD X 3MM.	3M X 101OD X 3MM	5M X 76OD X 3MM.	1500MM
11,5M	10M	3M X 139OD X 3MM.	6M X 101OD X 3MM	2,5M X 76OD X 3MM.	1500MM
12M	10,5M	3M X 139OD X 3MM.	6M X 101OD X 3MM	3M X 76OD X 3MM.	1500MM
12,5M	11M	3M X 139OD X 3MM.	6M X 101OD X 3MM	3,5M X 76OD X 3MM.	1500MM
13M	11,5M	6M X 152OD X 3MM.	3M X 101OD X 3MM	4M X 76OD X 3MM.	1500MM
13,8M	12M	6M X 152OD X 3MM	6M X 101OD X 3MM	2M X 76OD X 3MM.	1800MM

CURVED POLE

Curved Pole with Banner

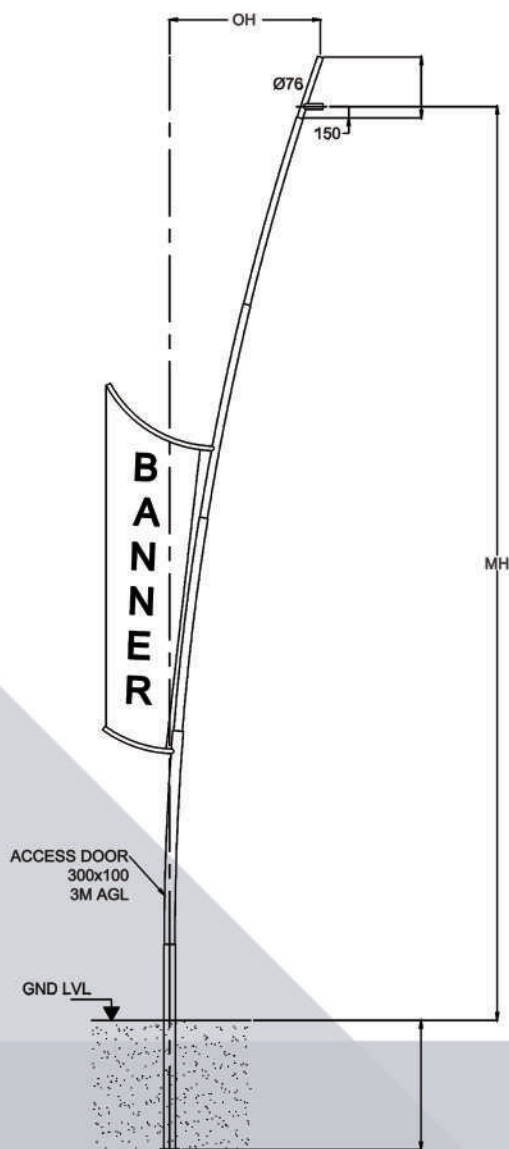

Curved Pole - 12m

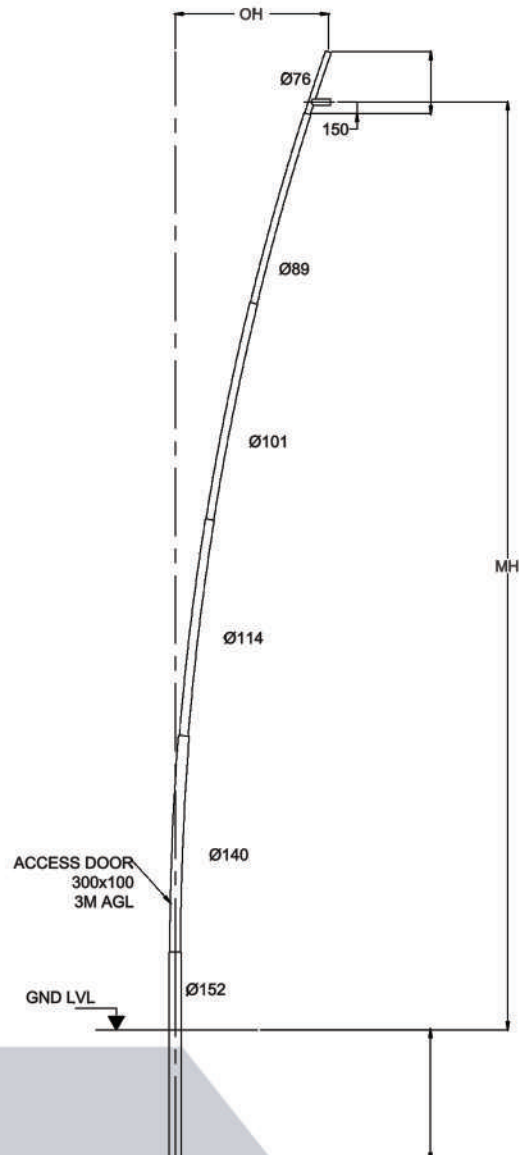

Decorative Designs

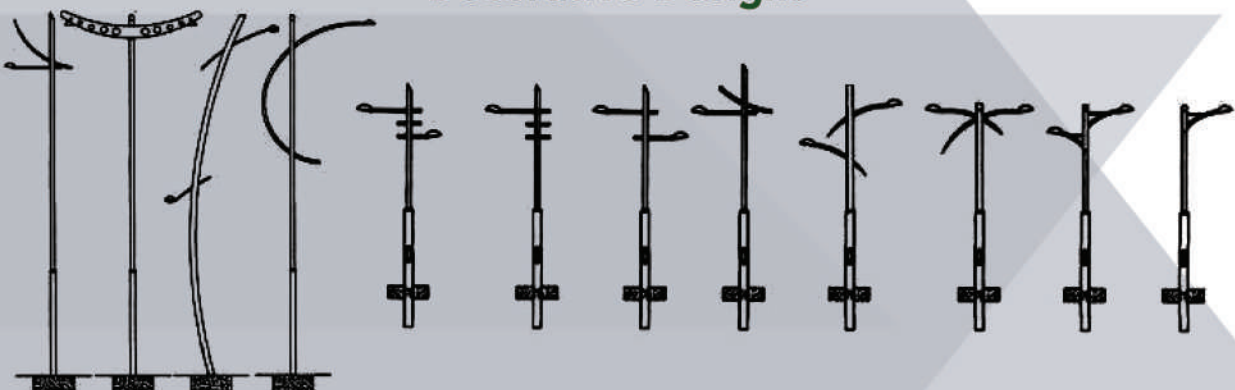

MID HINGE MASTS 6M - 25M



Accessories

Spigots

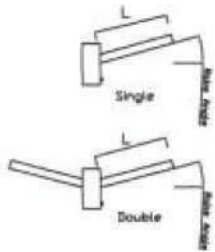

Wooden Pole Brackets

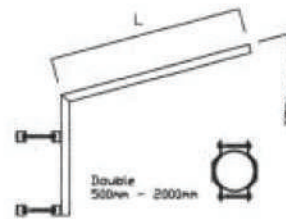
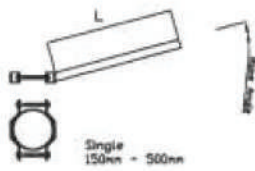

Post Top Brackets

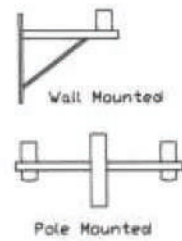

Floodlight Brackets

2, 3, & 4 WAY FLOOD LIGHT MOUNTINGS



2 WAY FLOOD LIGHT BCKT

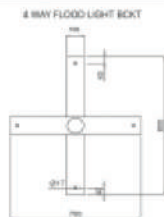

4 WAY FLOOD LIGHT BCKT

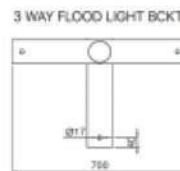

3 WAY FLOOD LIGHT BCKT

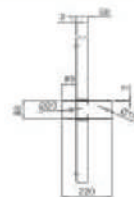

SIDE VIEW FLOOD LIGHT BCKT

CURVED MASTS & RAILOW MASTS

9m Curved Masts

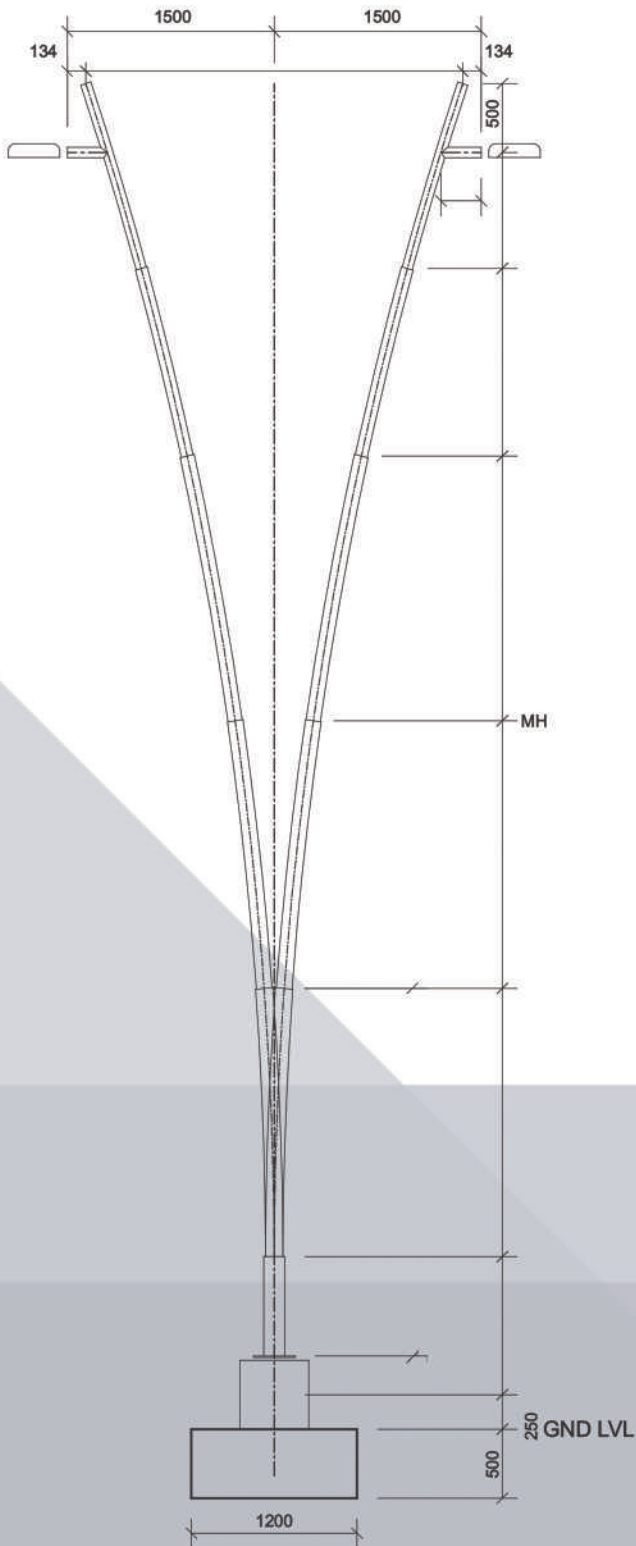

Railow Masts 15m - 40m

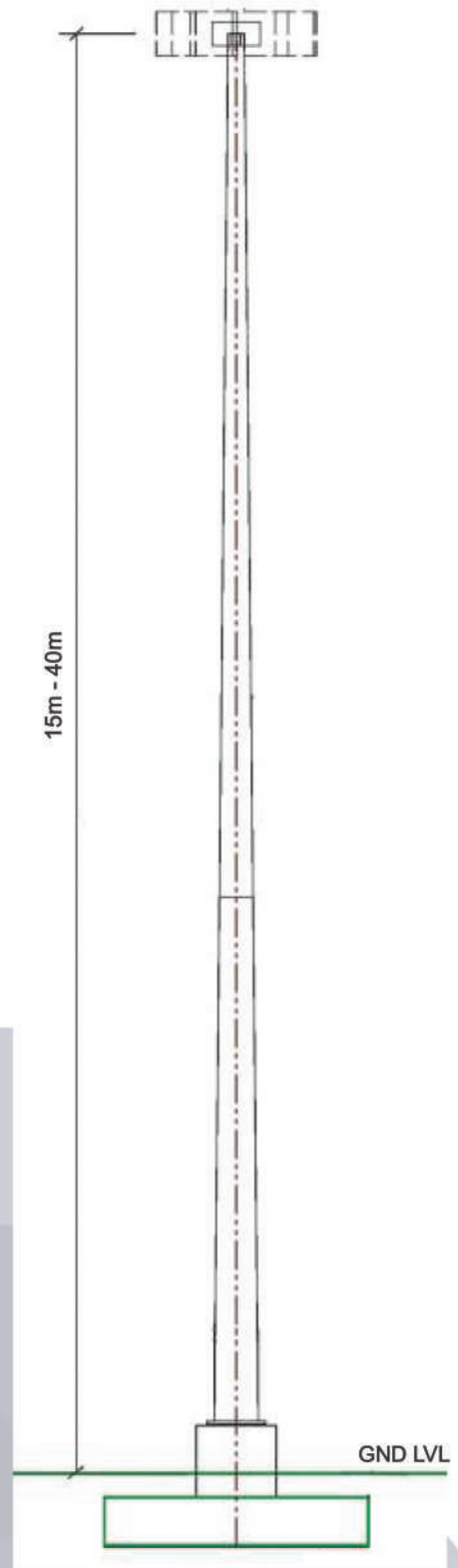

c/w DOUBLE & CURVED OUTREACH

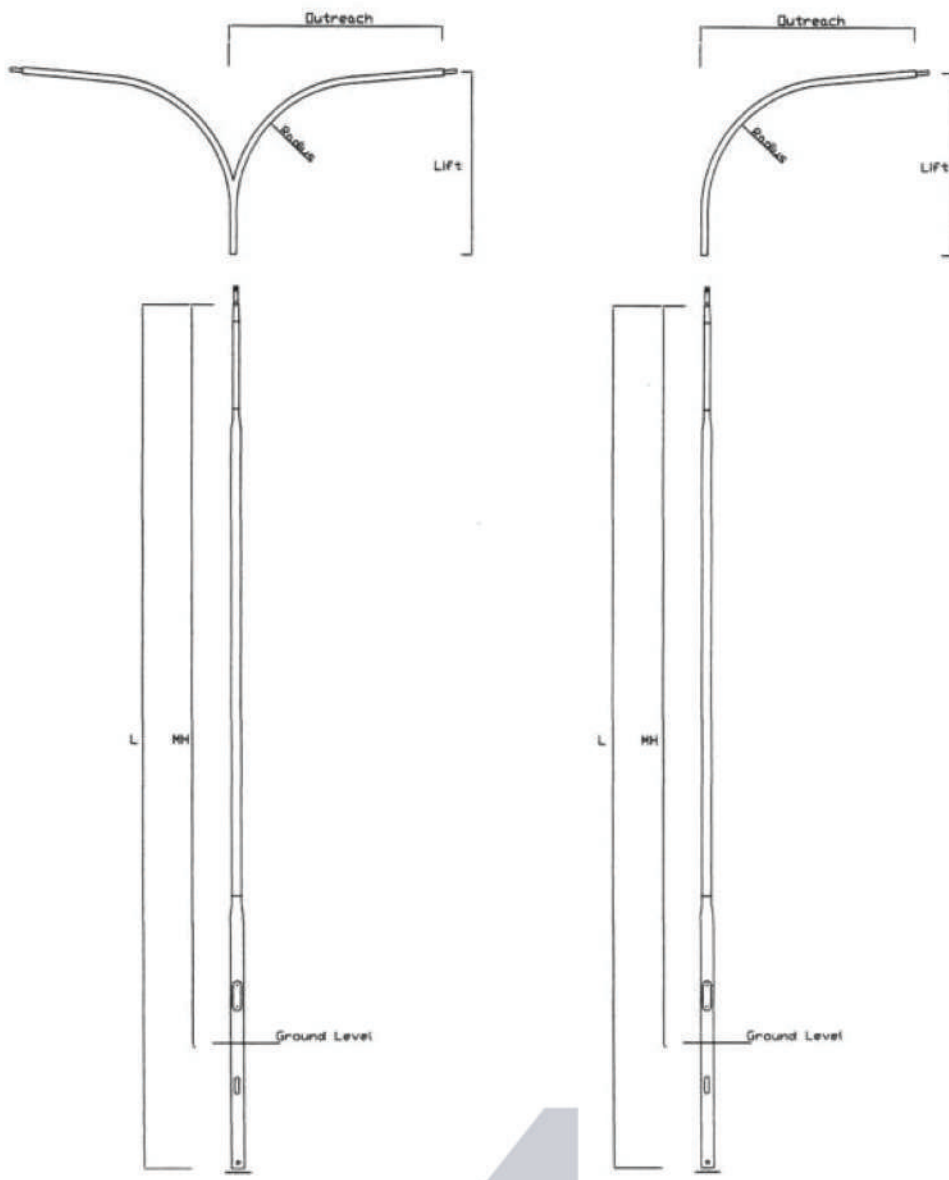

Pole & Mast Specifications

- Poles and masts are designed and manufactured in accordance with SANS10225
- All materials used are Grade GW355J High Tensile to SANS657-1
- All welding and welding procedures to SANS 10044 Parts1-4
- Hot Dip Galvanizing to ISO 1461/SANS121-2000-1
- Manufacturing to SANS10214-1987-1
- We are a member of POLASA

LIGHTS

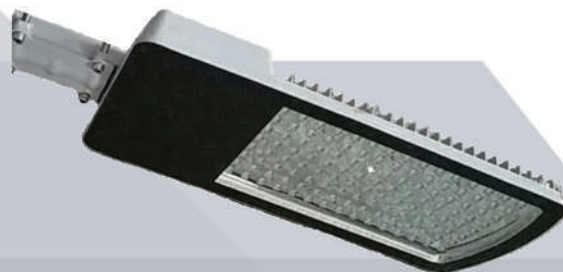
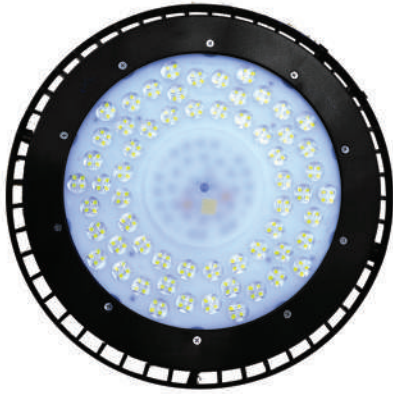

Features

- Multiple Wattages Available
- LED & Normal
- LED/HPS/MH/CFL



Street Lighting & Post Tops





KED LED WATER PROOF FIXTURE



Features

Microwave Sensor

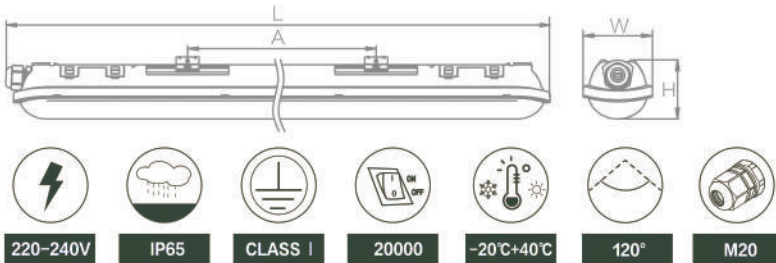

CAT NO.	L (mm)	W (mm)	H (mm)	WATTAGE	LUMEN	INSTALL SIZE (mm)
KED LG06R-L-21	590	72	61	21W	2100lm	250-280
KED LG06R-L-40	1180	72	61	40W	4000lm	570-670
KED LG06R-L-55	1480	72	61	55W	5500lm	850-950

KED T8 LED Water Proof Fixture



Lamps

Iron: 18W, 36W

Aluminium: 18W, 28W, 36W

Features



CAT NO.	L (mm)	W (mm)	H (mm)	WATTAGE	LUMEN	INSTALL SIZE (mm)
KED LG-06D-06S	580	66,5	63	9W	750lm	410
KED LG-06D-12S	1285	66,5	63	18W	1450lm	1015
KED LG-06D-15S	1585	66,5	63	24W	1900lm	1315
KED LG-06D-06	580	112,5	63	2X9W	1400lm	410
KED LG-06D-12	1285	112,5	63	2X18W	2500lm	1015
KED LG-06D-15	1585	112,5	63	2X24W	3600lm	1315

KED LED WATER PROOF FIXTURE

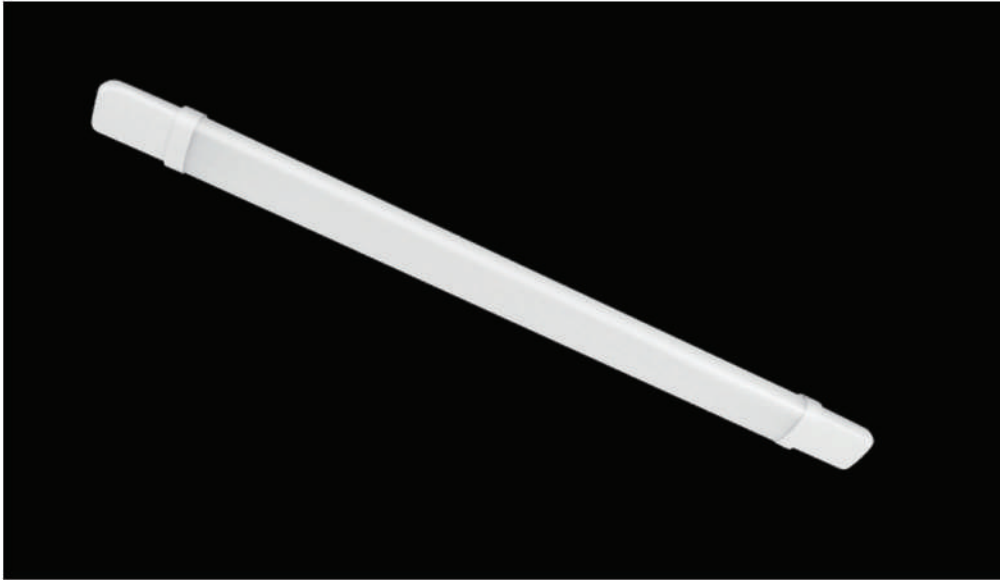

Features



220-240V IP65 CLASS II 20000 -20°C+40°C 120° M12/M16

CAT NO.	L (mm)	W (mm)	H (mm)	WATTAGE	LUMEN	INSTALL SIZE (mm)
KED LG06P-06-10	700	53	35	10W	900lm	370
KED LG06P-06-18	700	53	35	18W	1600lm	370
KED LG06P-12-18	1230	53	35	18W	1600lm	880
KED LG06P-12-36	1230	53	35	36W	3500lm	880
KED LG06P-15-24	1510	53	35	24W	2160lm	1150
KED LG06P-15-45	1510	53	35	45W	4300lm	1150

KED T8 LED Water Proof Fixture



Lamps

T8 LED Tube

Features



220-240V



IP65



CLASS I



20000



-20°C+40°C



120°



M16

CAT NO.	L (mm)	W (mm)	H (mm)	WATTAGE	LUMEN	INSTALL SIZE (mm)
KED LG118A-E	590	86	66	1X9W	750lm	420
KED LG136A-E	590	86	66	1X18W	1450lm	900
KED LG158A-E	1180	86	66	1X24W	1900lm	1000
KED LG218A-E	1180	86	66	2X9W	1400lm	420
KED LG236A-E	1480	86	72	2X18W	2500lm	900
KED LG258A-E	1480	86	72	2X124W	3600lm	1000

KED LED T8 Bracket

CAT NO.	L (mm)	W (mm)	H (mm)
KED LED-T8-DF-A6	632	85	33
KED LED-T8-DF-A6	1232	85	33
KED LED-T8-DF-A6	1554	85	33

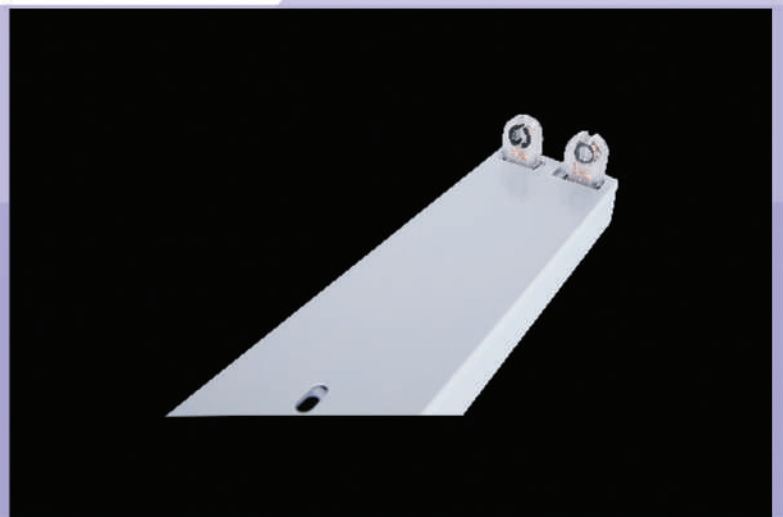

KED IP20 Flat Fixture Light

Lamps

Iron: 18W, 36W

Aluminium: 18W, 28W, 36W

Features

- Available in 3000K, 4000K and 6500K

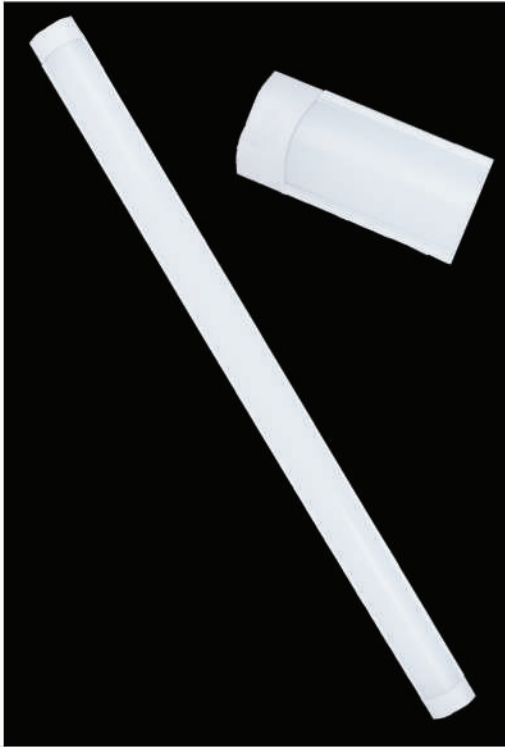

Material

- Iron
- Aluminium

CAT NO.	L (mm)	W (mm)	H (mm)	WATTAGE	MATERIAL
KED IP20-A1-600	600	75	23	18	Iron
KED IP20-A1-1200	1200	75	23	36	Iron
KED IP20-A2-600	600	75	23	18	Aluminium
KED IP20-A2-900	900	75	23	28	Aluminium
KED IP20-A2-1200	1200	75	23	36	Aluminium

KED SURFACE MOUNTED LED LAMP

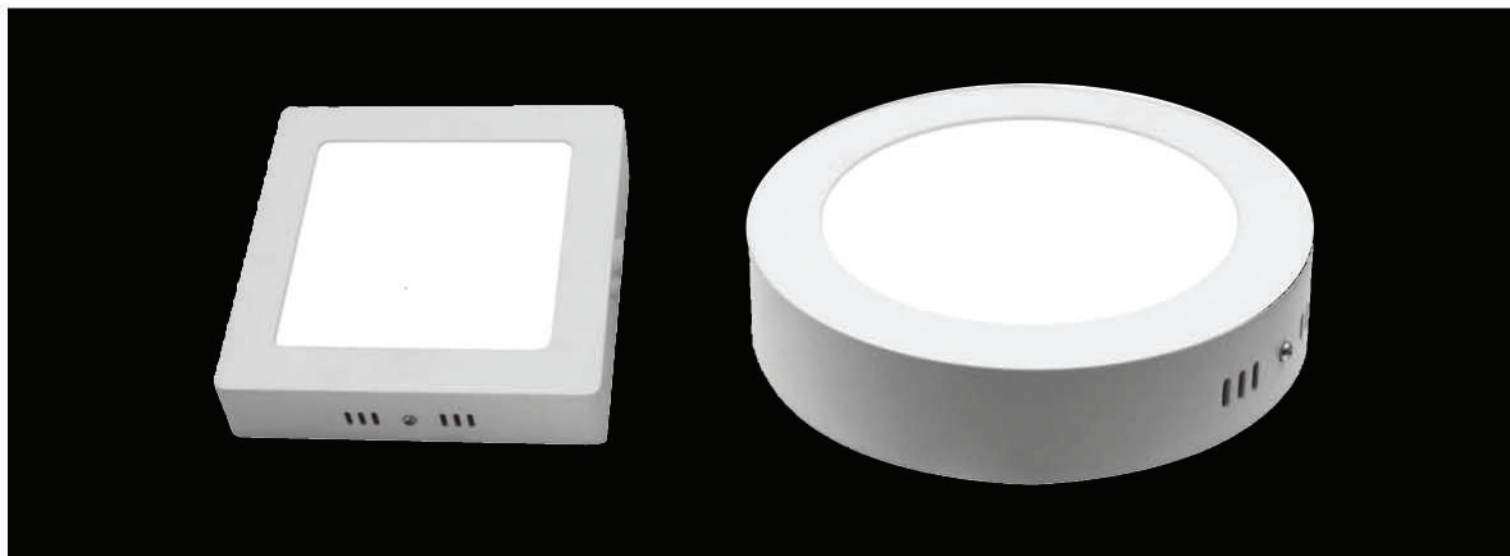

Features

Material Die Casting Aluminium

Lifespan: 50 000H

Square

CAT NO.	L (mm)	W (mm)	H (mm)	WATTAGE	LUMEN
KED-511-SS-6W	120	120	40	6W	420lm
KED-512-SS-12W	170	170	40	12W	820lm
KED-513-SS-18W	225	225	40	18W	1200lm
KED-514-SS-24W	300	300	40	24W	1680lm

Round

CAT NO.	D (mm)	H (mm)	LUMEN	WATTAGE
KED-515-SR-6W	120	40	540lm	6W
KED-516-SR-12W	170	40	1080lm	12W
KED-517-SR-18W	225	40	1200lm	18W
KED-518-SR-24W	300	40	1350lm	24W

KED LED PANEL LIGHT

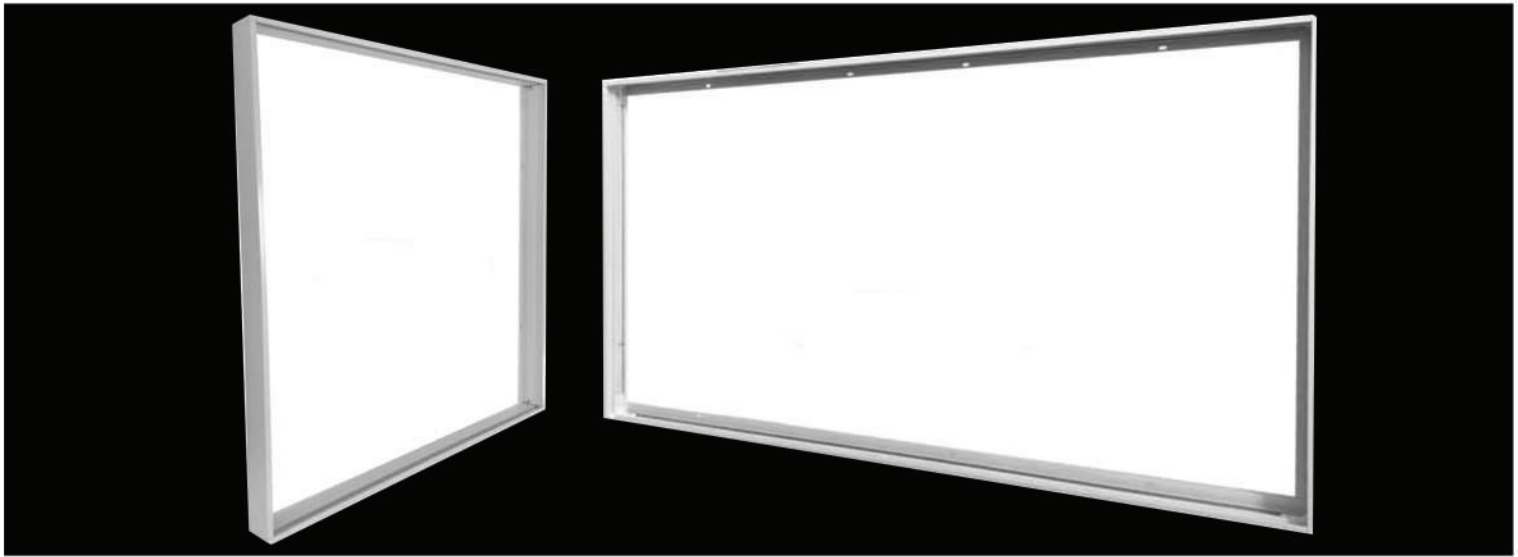

Features

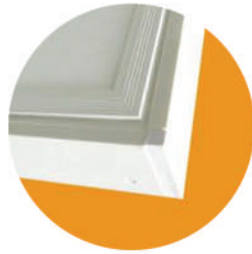

Parts



CAT NO.	L (mm)	W (mm)	MATERIAL
KED 519-LGP-PS-F	595	595	Aluminium
KED 520-LGP-MS-F	595	1195	Aluminium

KED RECESSED GRILLE

Lamps

T8 Fluorescent

Features

- High quality steel body. Dealed with phosphide the powder coating
- Aluminium (Mirror, matt) with film reflector
- Standard magnetic ballast

For use in Offices, Libraries, Schools, Hospitals, Malls, Supermarkets, Hotel, etc



CAT NO.	L (mm)	W (mm)	H (mm)	WATTAGE
KED YLA 320	595	595	75	3x18W
KED YLA 340	1195	595	75	3x36W

Space illumination curve (Unit: lx)

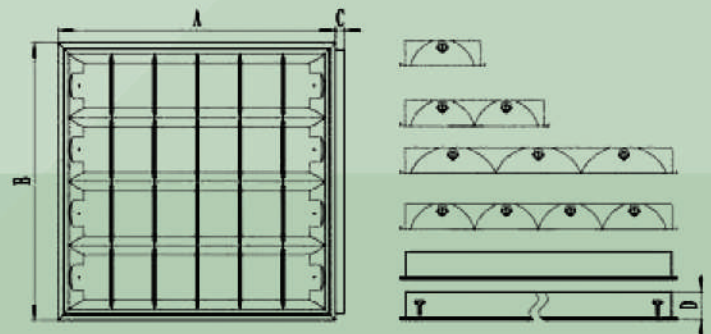
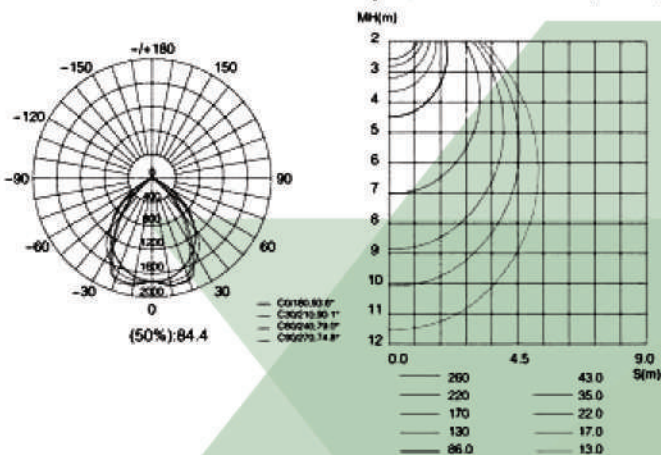

T8 RECESSED SOFT LIGHT



Lamps

T8 Fluorescent

Features

- High quality steel body. Dealed with phosphide the powder coating
- Aluminium (Mirror, matt) with film reflector
- Standard magnetic ballast

For use in Offices, Libraries, Schools, Hospitals, Malls, Supermarkets, Hotel, etc

CAT NO.	L (mm)	W (mm)	H (mm)	WATTAGE
KED YLA 240S	1232	295	75	2X36W
KED YLA 258S	1532	295	75	2X58W
KED YLA 320S	622	595	75	3x18W
KED YLA 340S	1232	595	75	3x36W
KED YLA 358S	1532	595	75	3X58W
KED YLA 440S	1232	595	75	4X36W
KED YLA 458S	1532	595	75	4X58W

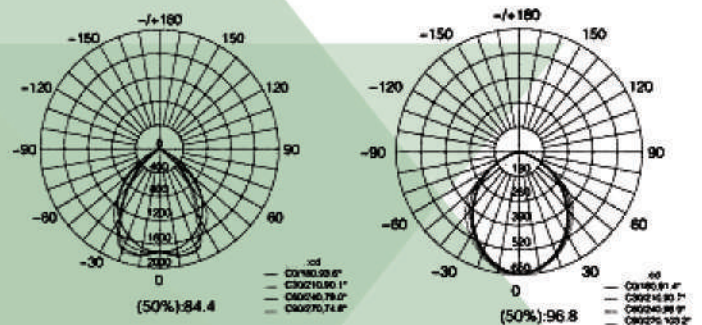
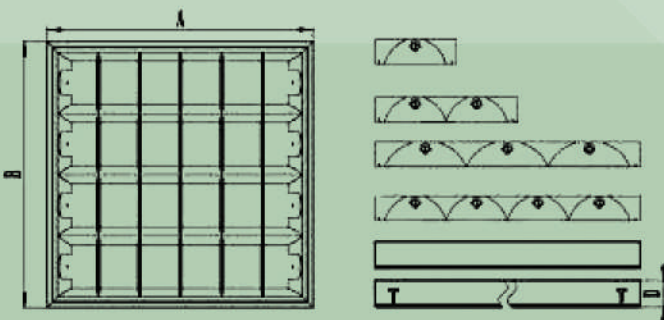

KED RECESSED LED DIFFUSER

Lamps

T8 Fluorescent

Features

- High quality steel with PC/PE/PMMA(clarity, ivory) cover
- Standard magnetic ballast

For use in Offices, Libraries, Schools, Hospitals, Malls, Supermarkets, Hotel, etc

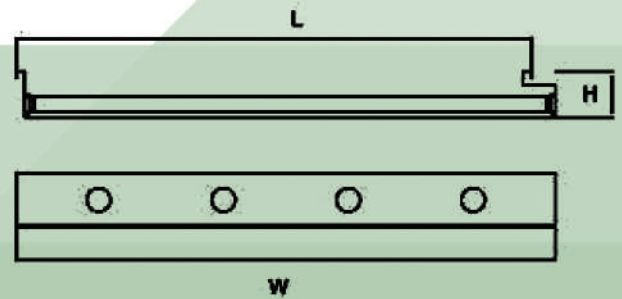
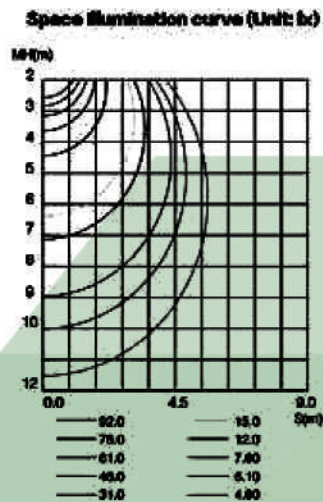
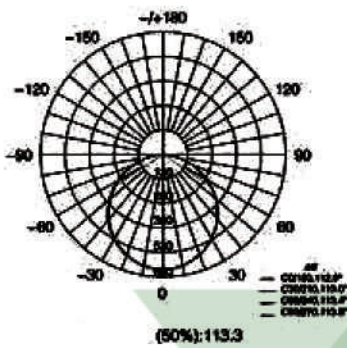

T8 SURFACE GRILLE



Lamps

T8 Fluorescent

Features

- High quality steel body. Dealed with phosphide the powder coating
- Aluminium (Mirror, matt) with film reflector
- Standard magnetic ballast

For use in Offices, Libraries, Schools, Hospitals, Malls, Supermarkets, Hotel, etc

CAT NO.	L (mm)	W (mm)	H (mm)	WATTAGE
KED YLA 240S	1232	295	75	2X36W
KED YLA 258S	1532	295	75	2X58W
KED YLA 320S	622	595	75	3x18W
KED YLA 340S	1232	595	75	3x36W
KED YLA 358S	1532	595	75	3X58W
KED YLA 440S	1232	595	75	4X36W
KED YLA 458S	1532	595	75	4X58W

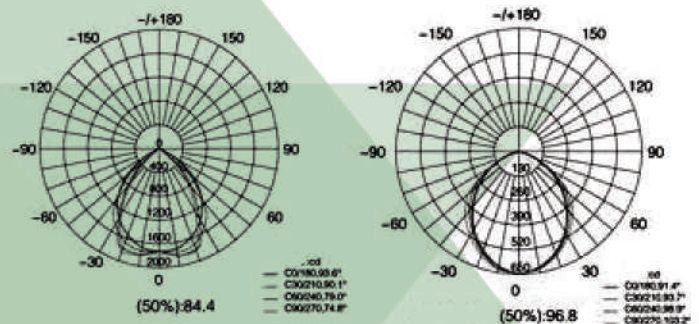
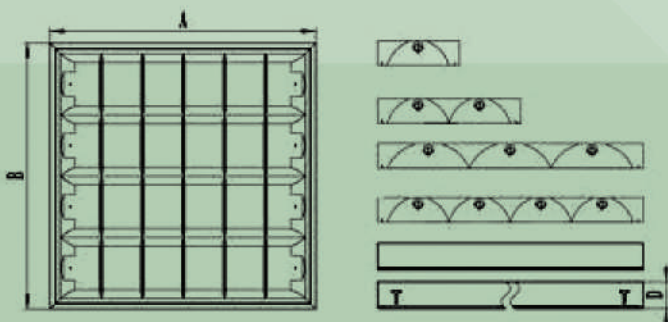

KED RECESSED LED PANEL LIGHT

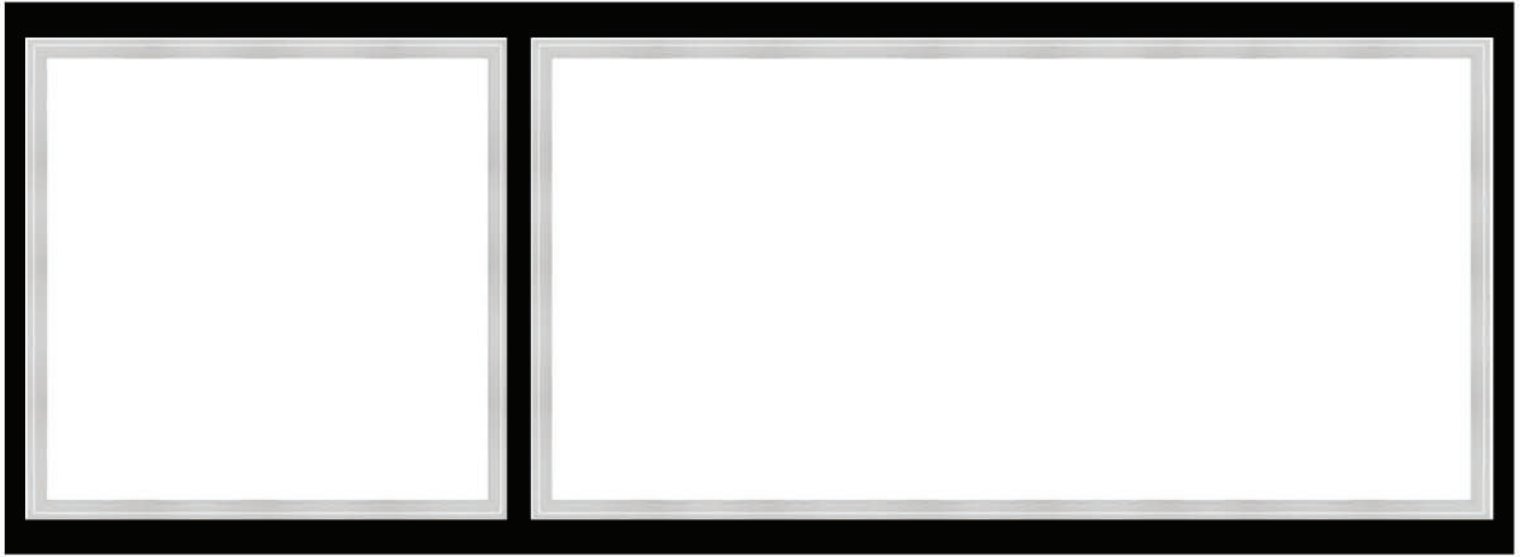

Features

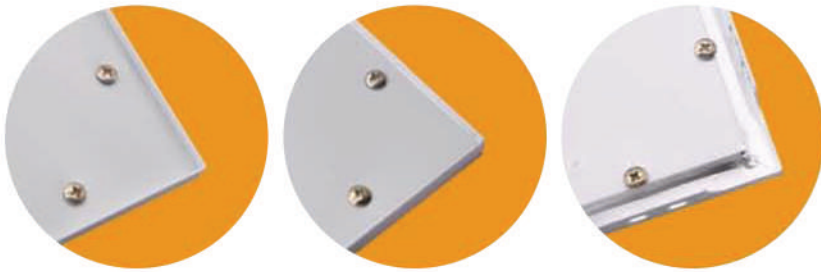

CAT NO.	L (mm)	W (mm)	LUMEN	WATTAGE
KED LGP-PS-48	595	595	3840lm	48W
KED LGP-MS-72	595	1195	5760lm	72W

KED CONCEALED LED LAMP

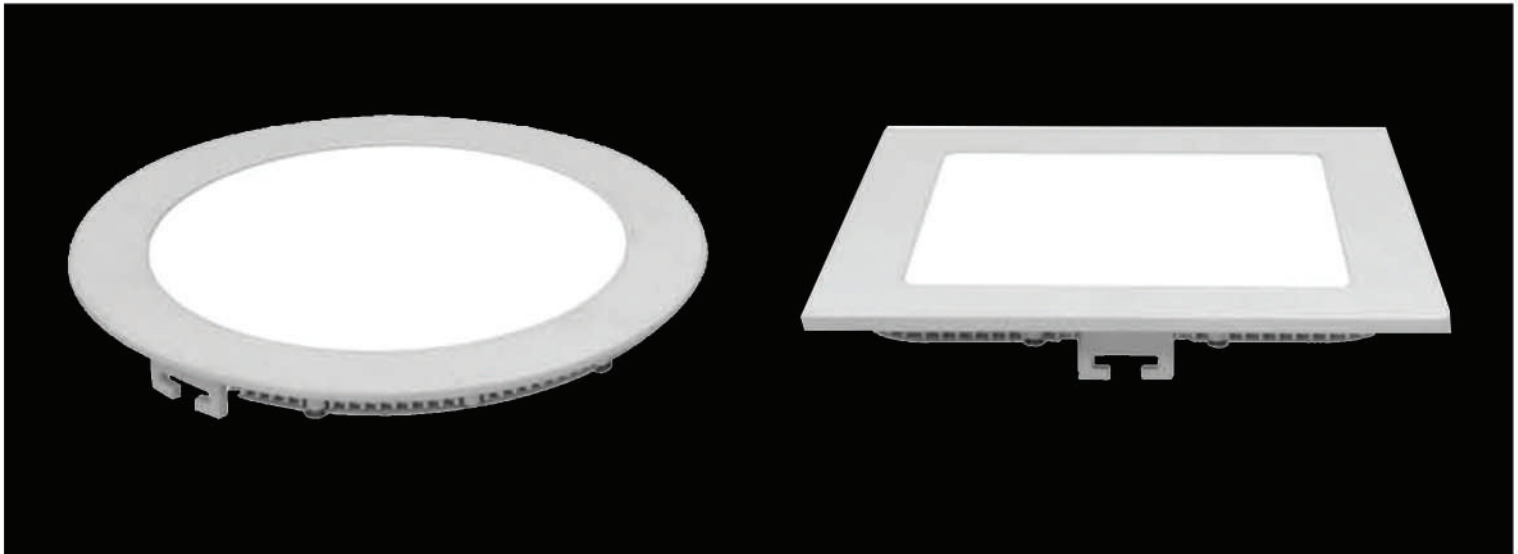

Features

Material Die Casting Aluminium

Lifespan: 50 000H

Input Voltage: AC85-265V 50/60Hz

Colour Temp: 4000K/6000K

Round

CAT NO.	D (mm)	H (mm)	LUMEN	WATTAGE	HOLE (mm)
KED-503-RR-3W	85	25	180lm	3W	70
KED-504-RR-6W	105	25	360lm	6W	105
KED-505-RR-12W	170	25	720lm	12W	155
KED-506-RR-18W	225	25	1080lm	18W	210

Square

CAT NO.	L (mm)	W (mm)	H (mm)	WATTAGE	LUMEN	HOLE (mm)
KED-510-RS-3W	85	85	25	3W	180lm	70
KED-511-RS-6W	120	120	25	6W	360lm	105
KED-512-RS-12W	150	150	25	12W	720lm	155
KED-513-RS-18W	225	225	25	18W	1080lm	210

KED LED Ceiling Light

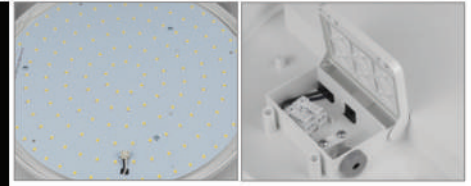

Features

Microwave Sensor

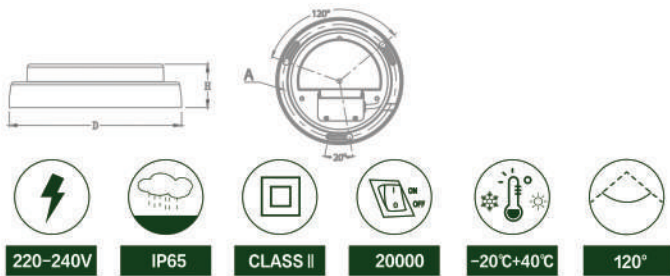

CAT NO.	D (mm)	H (mm)	WATTAGE	LUMEN	INSTALL SIZE (mm)
KED LG09M-220-15	220	55	15W	1250lm	67
KED LG09M-280-18	280	55	18W	1500lm	67
KED LG09M-330-24	330	55	24W	2050lm	67

KED LED WATER PROOF FIXTURE

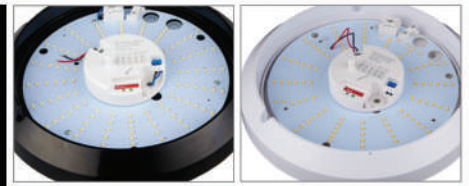

Features

Microwave Sensor

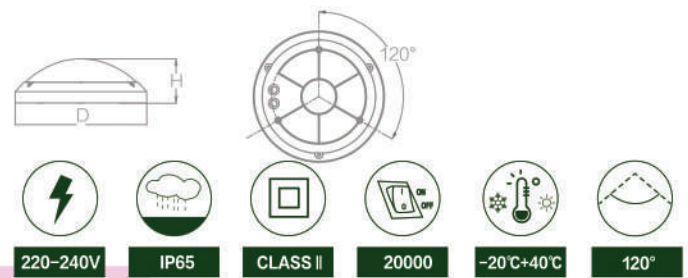

CAT NO.	D (mm)	H (mm)	WATTAGE	LUMEN	INSTALL SIZE (mm)
KED LG09C	294	99,5	16W	1250lm	211

CONTACT US

JOHANNESBURG (Head Office)

Khwaja Electrical Distributors

105 Jacoba Street, Norton Small Farms,
Germiston, Johannesburg, South Africa

011 869 8885

sales@khwajaelectrical.co.za
ishrath@khwajaelectrical.co.za

WWW.KHWAJAELECTRICAL.CO.ZA